

**Polymyxin applied to the respiratory tract fails to prevent
Acinetobacter associated ventilator associated pneumonia:
Benchmarking the evidence base**

James Hurley
ECCMID, April 2017,
Vienna, Austria

Disclosures

James Hurley has no conflicts of interest to declare

Ventilator Associated Pneumonia (VAP) & *Acinetobacter*

- VAP in ~20% of patients receiving MV
- *Acinetobacter* ~5% of isolates
- 20 CCT's of topical PM
- >40 CCT's of other interventions

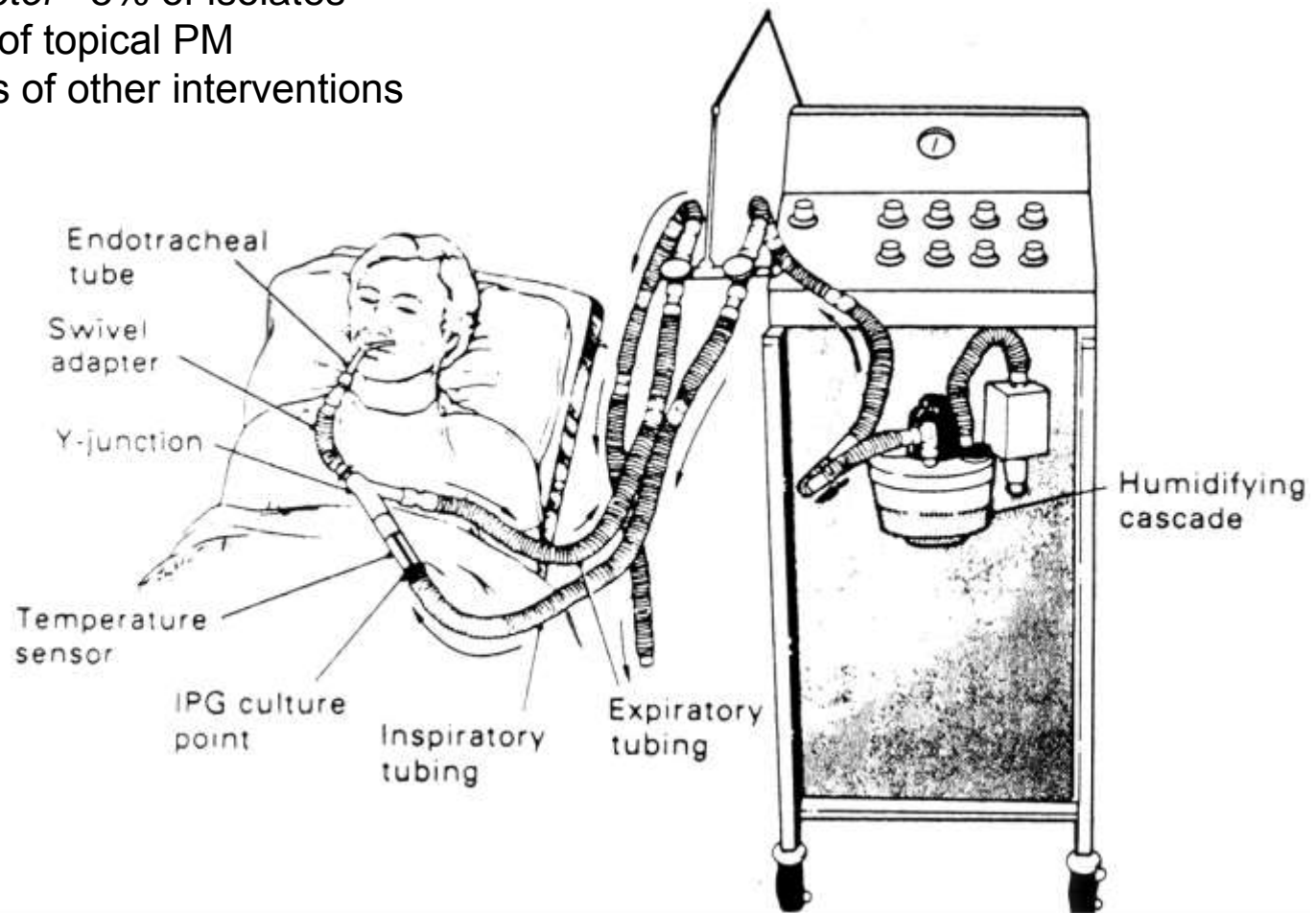

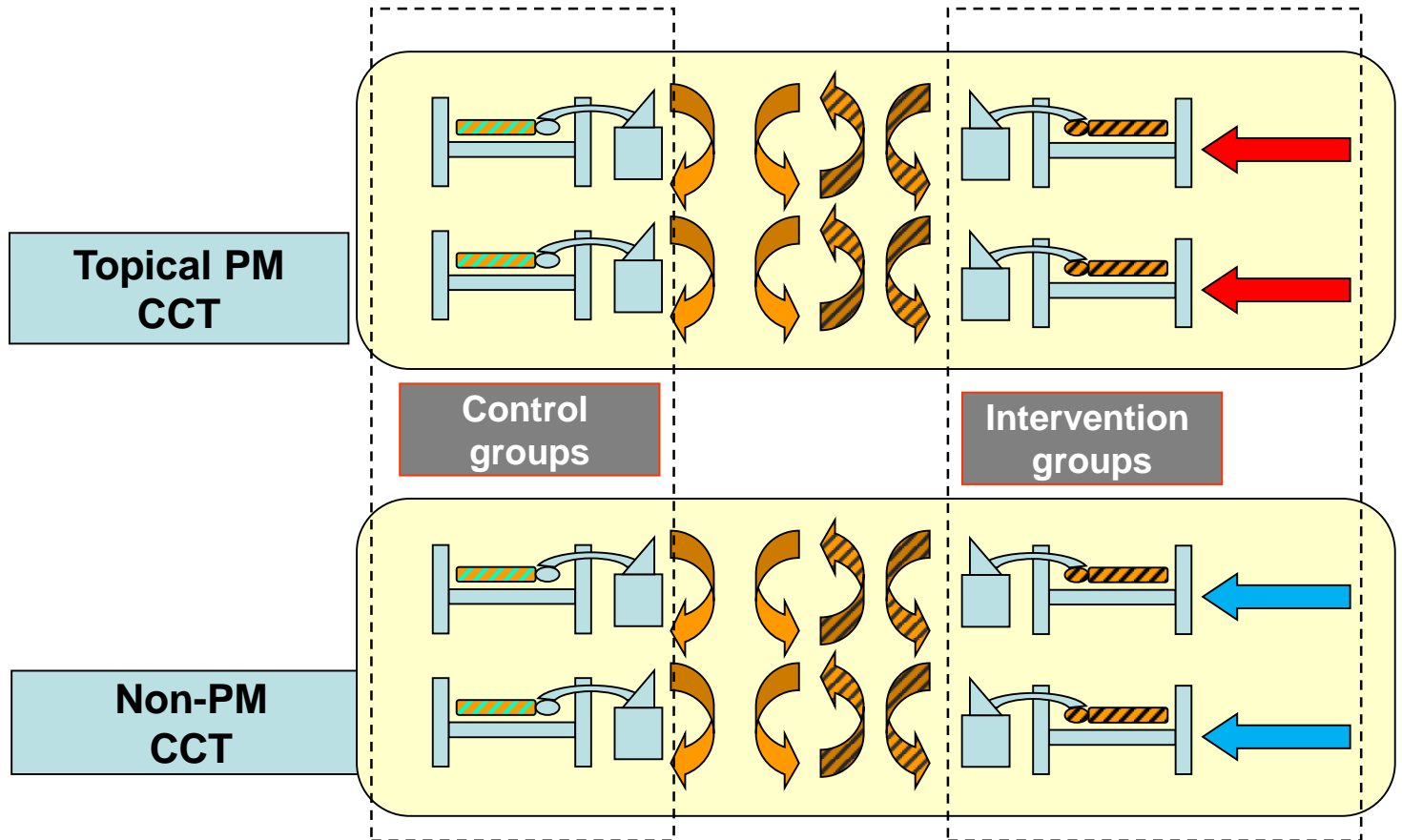
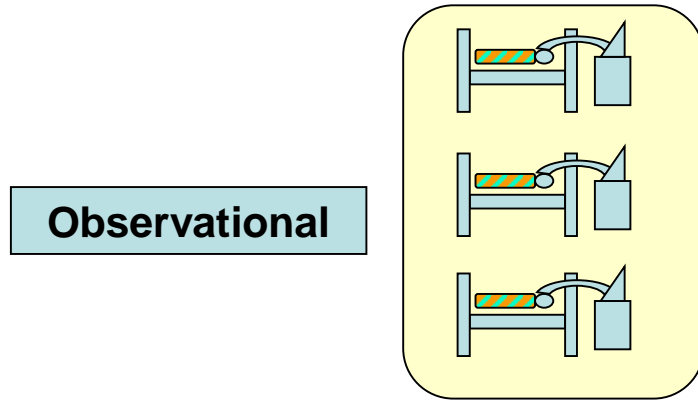

Flow chart of literature search, study and group decant and analysis plan

Electronic search terms
 •Ventilator associated pneumonia
 •AND Mechanical ventilation OR Intensive care unit
 •AND Systematic review OR meta-analysis

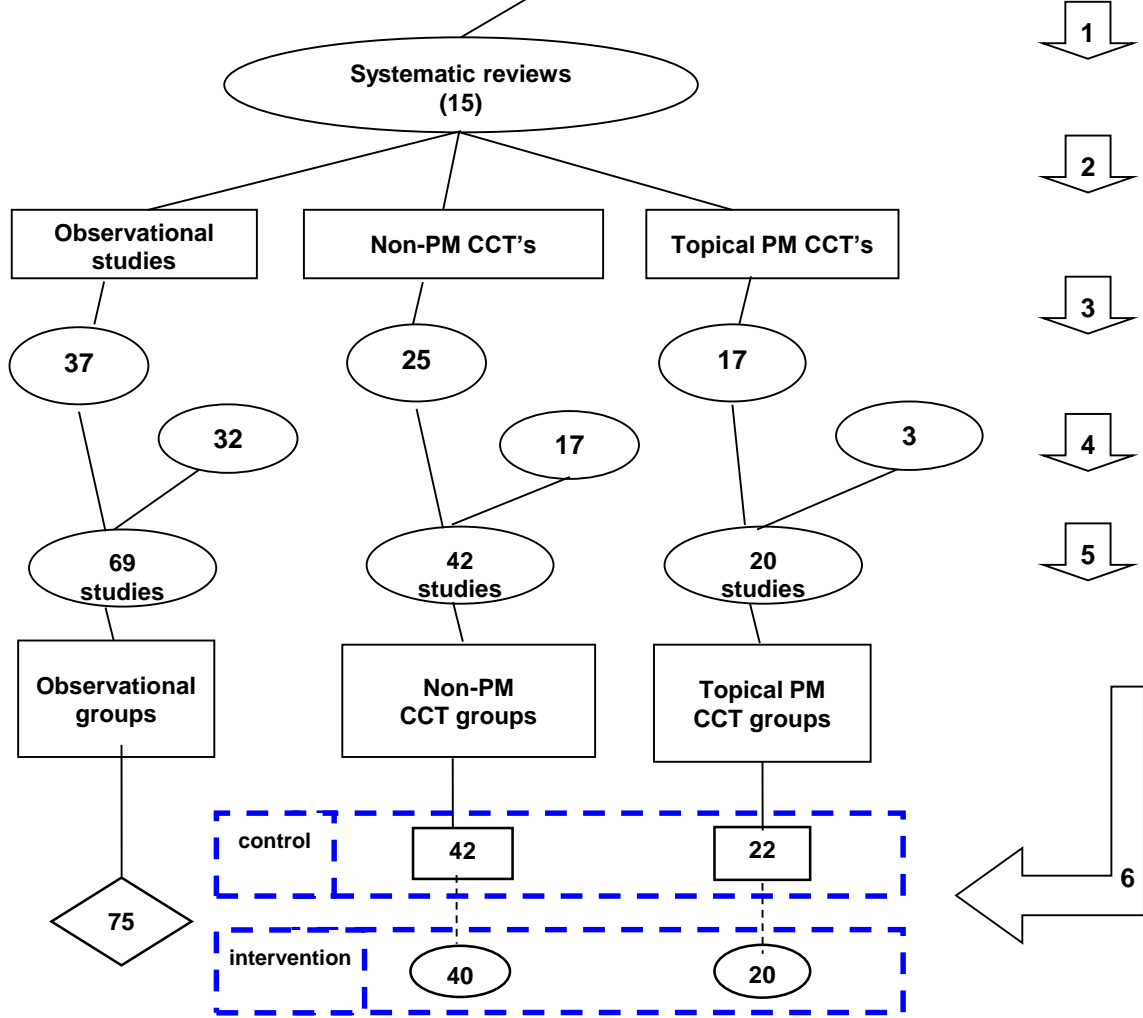

Summary odds ratios

	Non-PM studies		PM studies
	OR 95% CI (n)		OR 95% CI (n)
VAP	0.78; 0.69 – 0.88 (36)		0.37; 0.30 – 0.45 (21)
AAVAP	1.1; 0.72 – 1.61 (30)		0.59; 0.39 – 0.90 (15)

AAV: Benchmark groups (n=75)

Acinetobacter VAP incidence: Benchmark groups

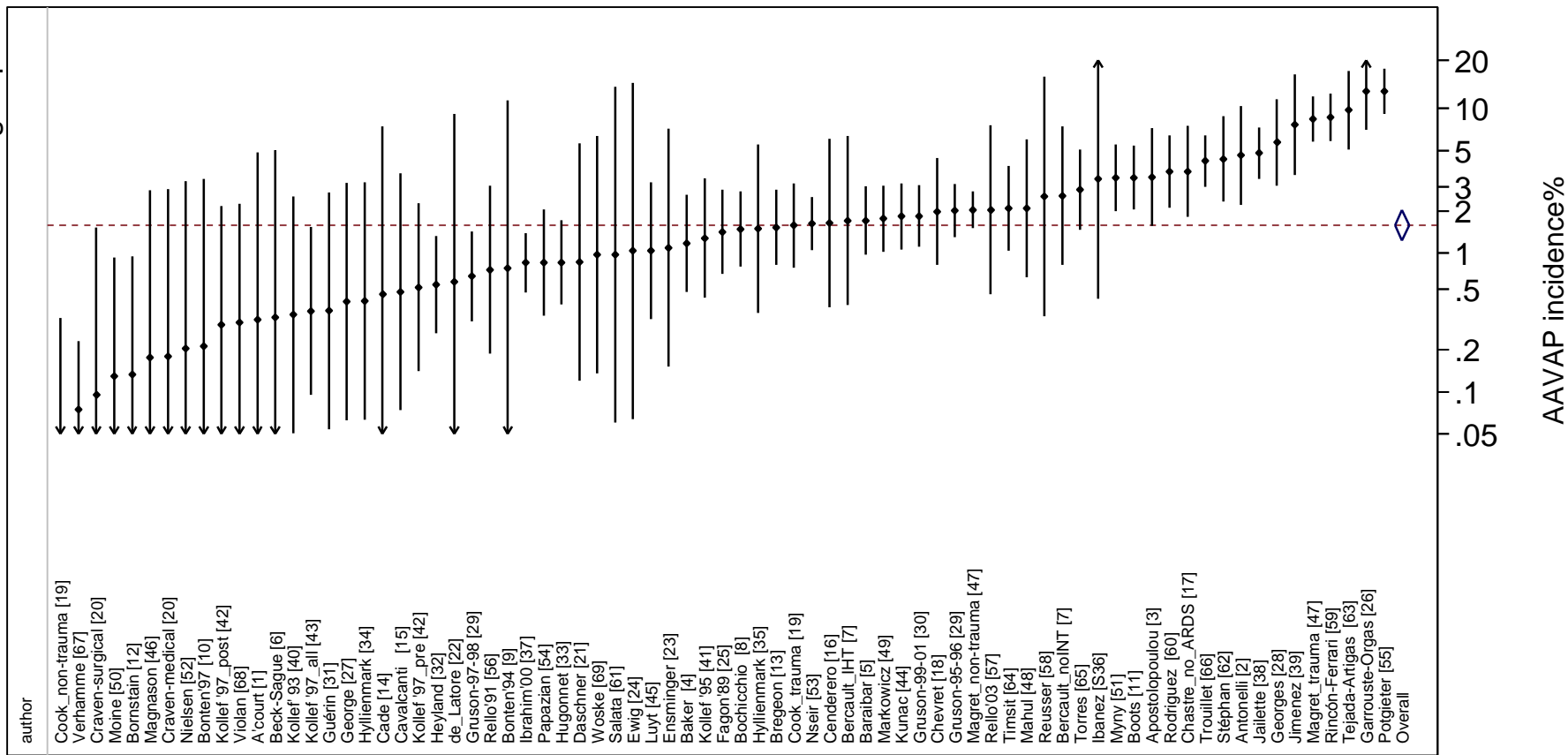

AAV : groups from non-PM CCT's (n = 42 & 40)

Acinetobacter incidence: Non-PM control groups

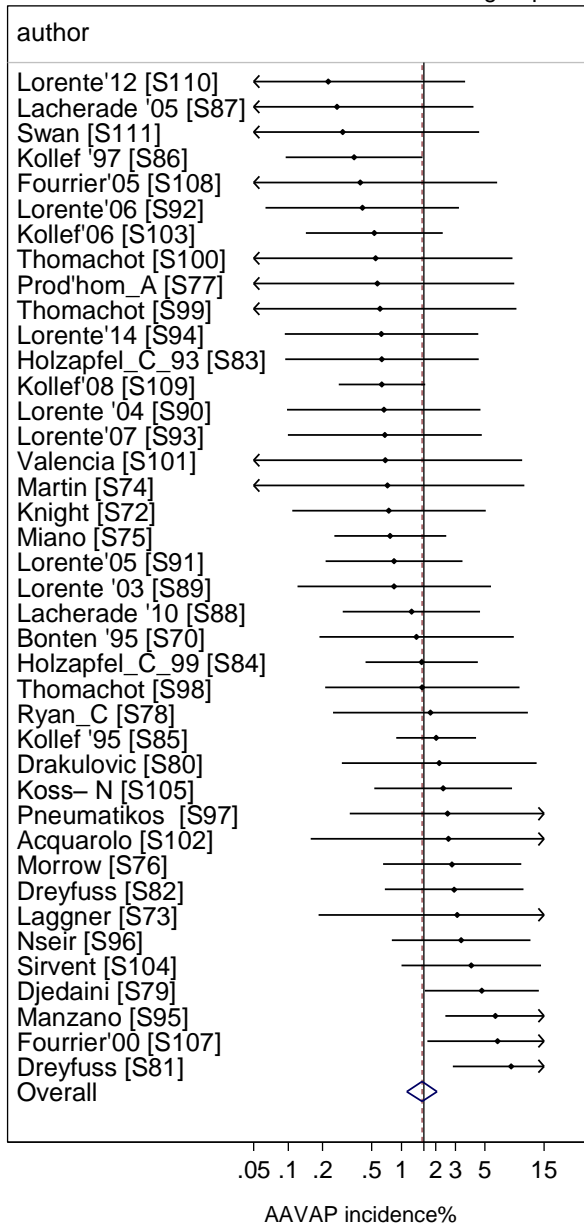

Acinetobacter incidence: Non-PM intervention groups

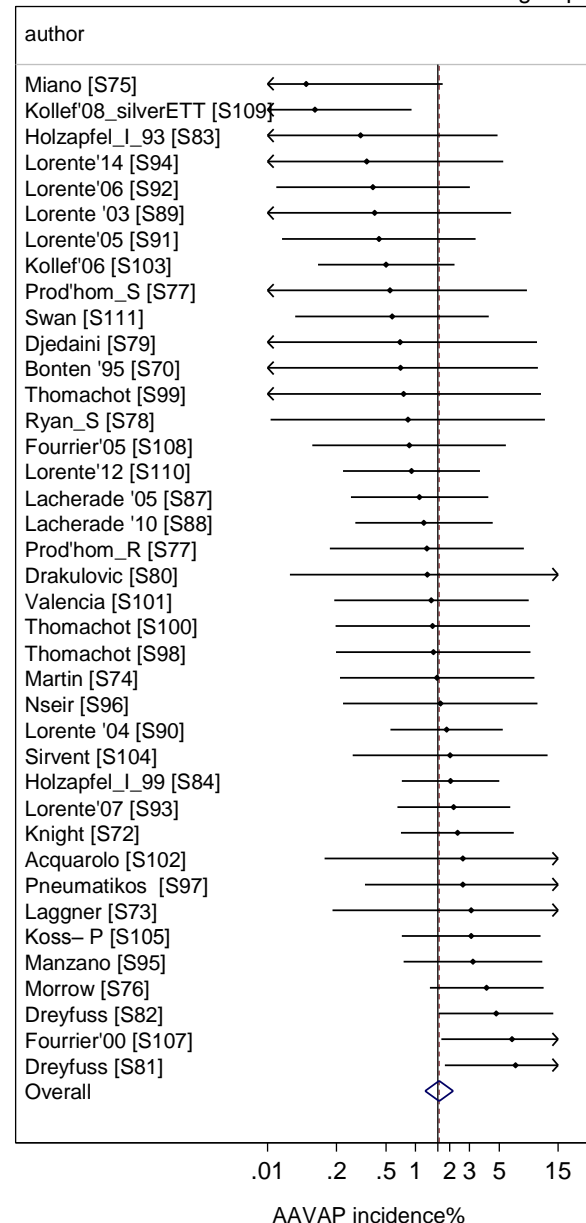

AAV: groups from PM CCT's (n = 22 & 20)

Acinetobacter incidence: topical PM groups

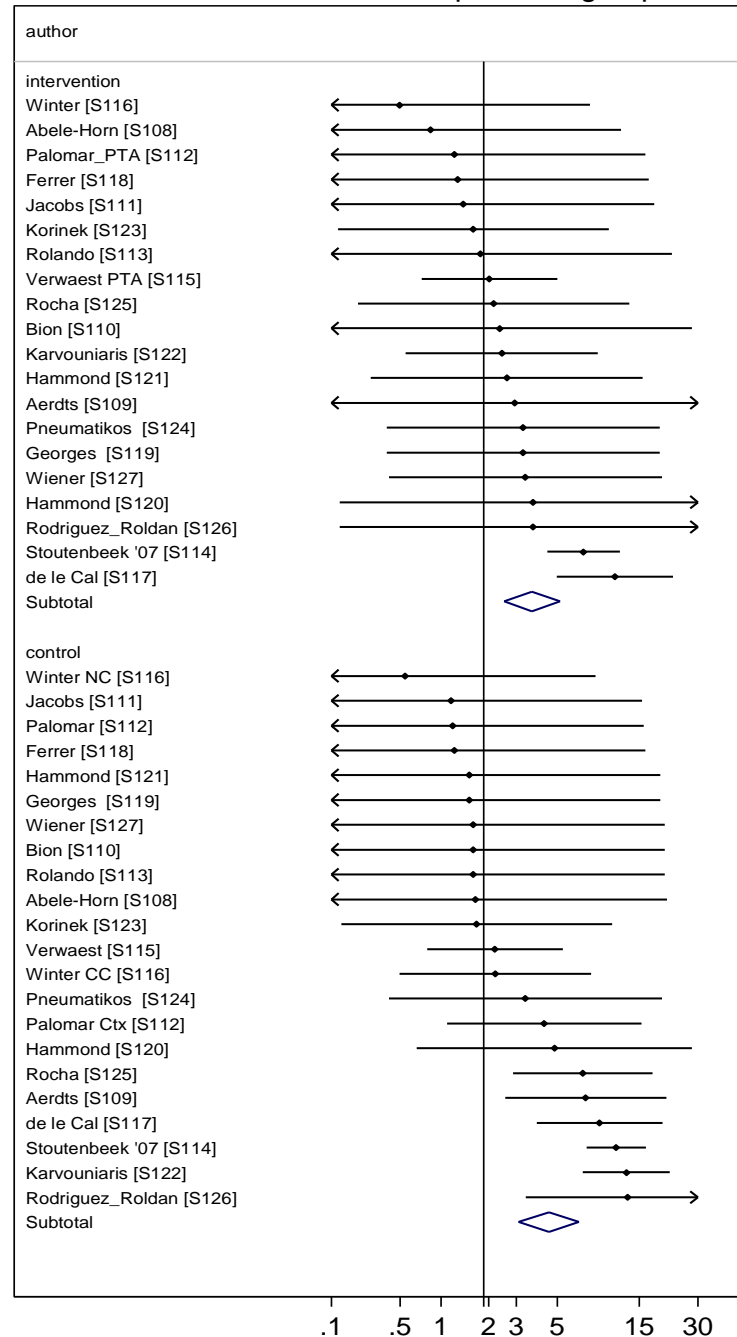

AAVAP: – all groups

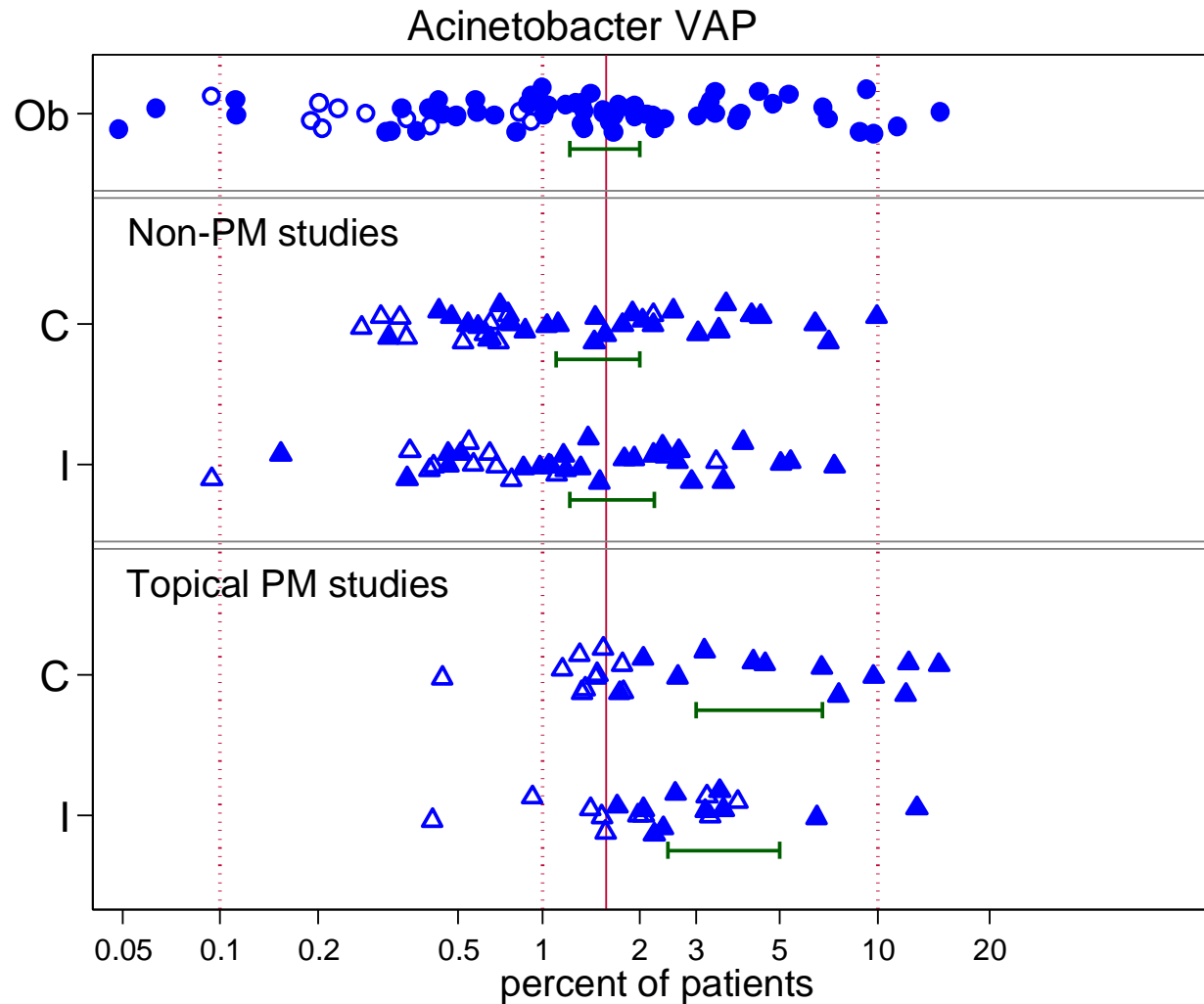

Acinetobacter bacteremia: – all groups

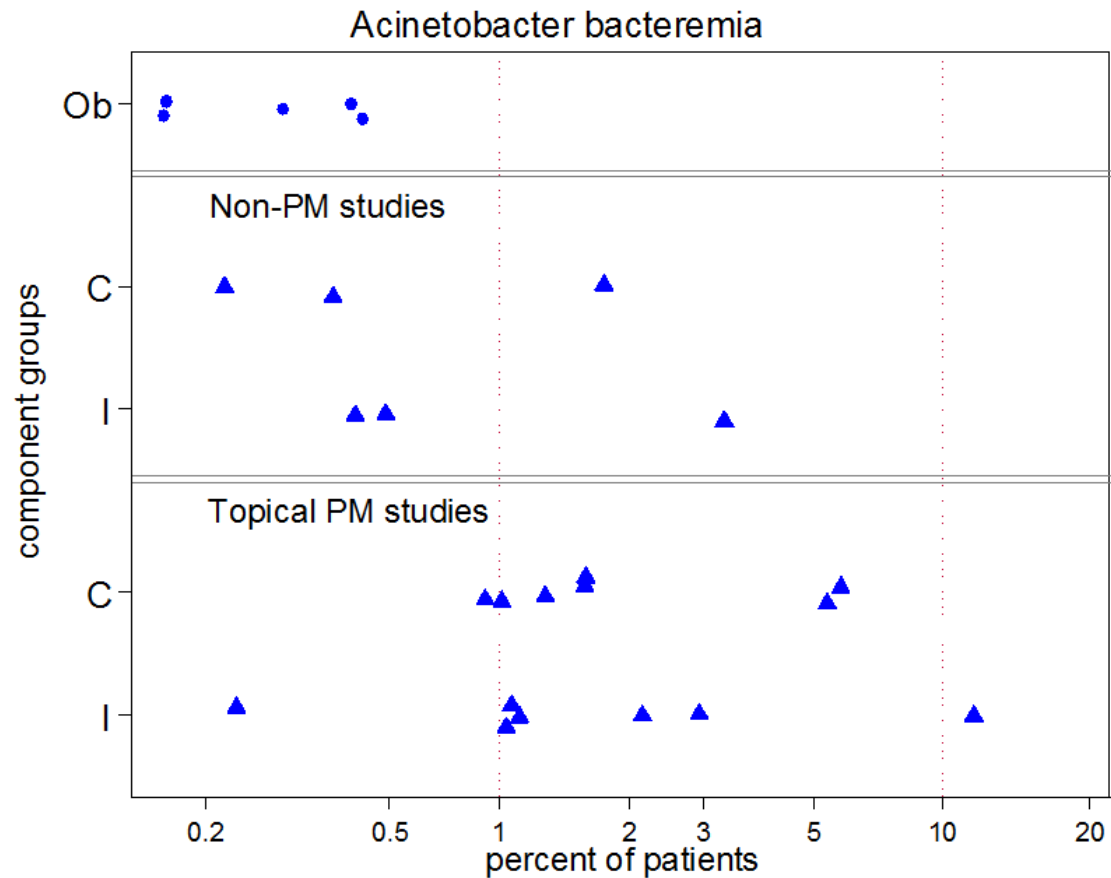

Conclusions

‘Horizontal’ analysis - (versus control groups)

- Apparent reduction in AAVAP for PM studies
- No apparent reduction in AAVAP for non-PM studies

‘Vertical’ analysis – (versus an external benchmark)

- Higher AAVAP incidence for groups of PM studies
 - versus an external benchmark
 - versus groups from non-PM studies
- Higher *Acinetobacter* bacteremia